

PARTS LIST

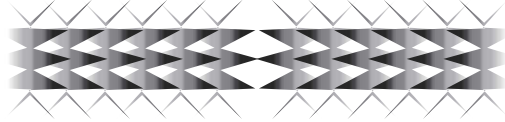

MODEL 1004

PARTS LIST

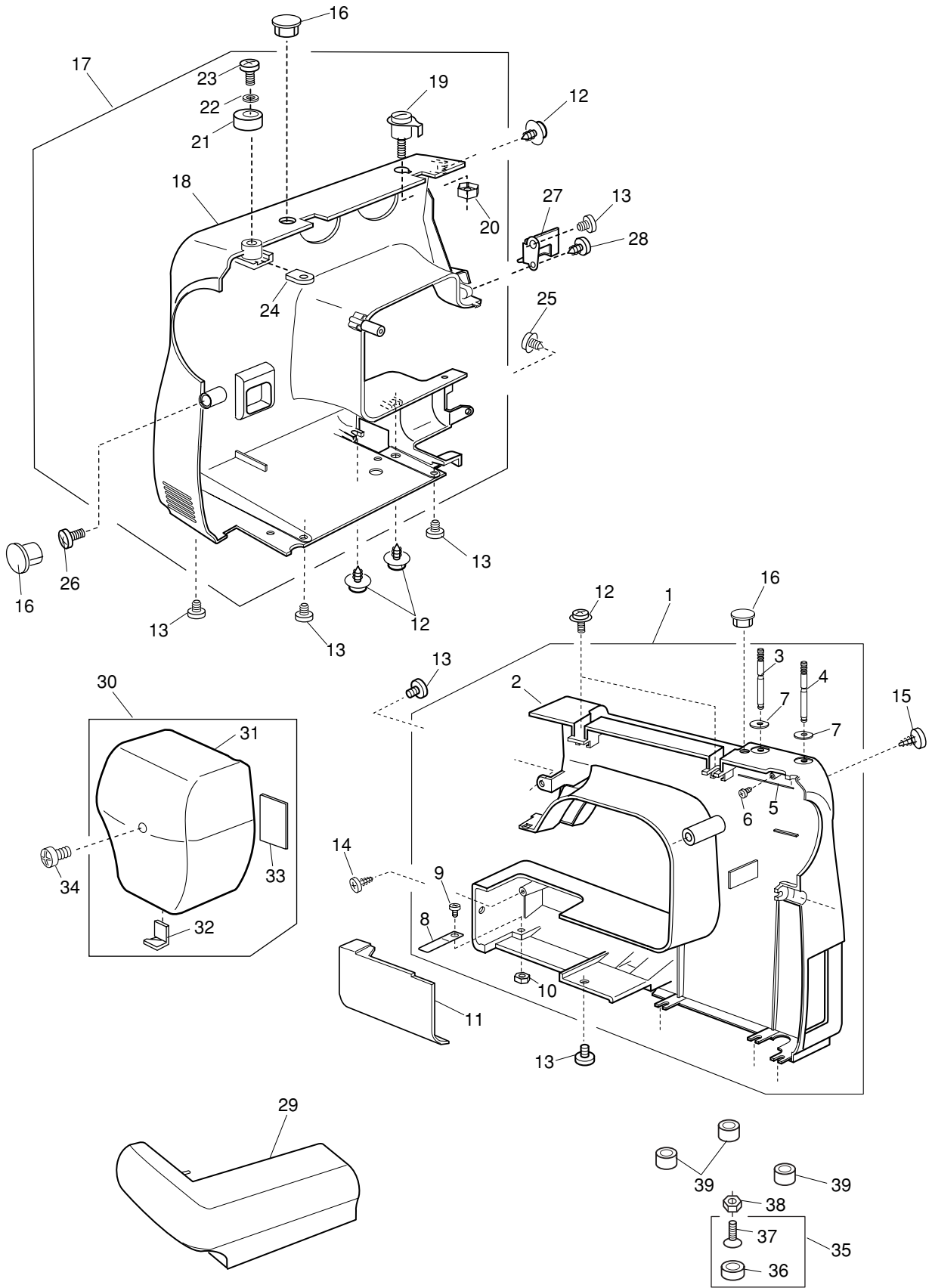

PARTS LIST

KEY NO.	PARTS NO.	DESCRIPTION	REMARK
1	306601015	REAR COVER (UNIT)	
2	306101102	REAR COVER	
3	652302004	SPOOL PIN	
4	652205006	SPOOL PIN	
5	736007009	SPOOL PIN SPRING	
6	000076317	TAPPING SCREW 3X10	
7	735013005	SPOOL PIN SPRING BASE	
8	730006000	SPRING	
9	000101404	SETSCREW 4X6	
10	000061205	NUT	
11	739004005	BED COVER PLATE	
12	000115205	TP SCREW 4X6	
13	000081005	SETSCREW 4X8	
14	000121905	TAPPING SCREW 4X12B	
15	000198604	TAPPING SCREW 4X14B	
16	653006101	CAP	
17	306604133	FRONT COVER (UNIT)(1004)	
18	306109166	FRONT COVER (1004)	
19	730501044	THREAD GUIDE PLATE (UNIT)	
20	000160102	ADJUSTABLE LOCK NUT 4	
21	735016307	BOBBIN WINDER STOPPER	
22	000071013	WASHER	
23	000103107	SETSCREW 4X14	
24	843014004	NUT	
25	000115607	TP SCREW 4X8	
26	000101703	SETSCREW 4X12	
27	745031000	THREAD GUIDE PLATE	
28	000107307	TAPPING SCREW 3X8B	
29	306102000	EXTENSION TABLE (UNIT)	
30	306602304	FACE COVER (UNIT)	
31	306103300	FACE COVER	
32	840602006	THREAD CUTTER (UNIT)	
33	724025006	REFLEX STICKER	
34	000080901	SETSCREW 4X25	
35	735616200	RUBBER BASE (UNIT)	
36	735002001	RUBBER BASE	
37	000097901	FLAT SCREW M5X18	
38	000061319	NUT	
39	739064003	BED RUBBER BASE	

PARTS LIST

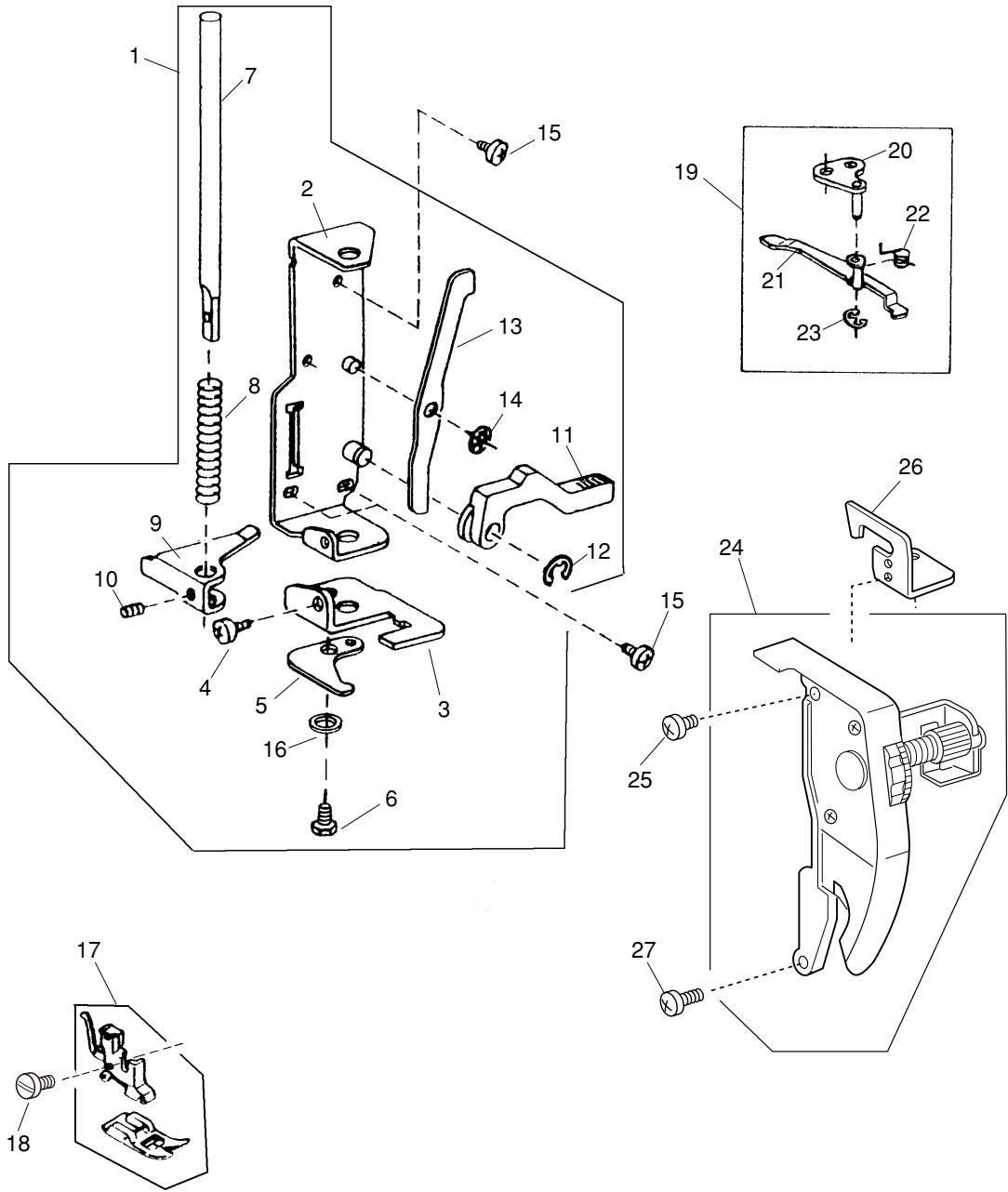

PARTS LIST

KEY NO.	PARTS NO.	DESCRIPTION	REMARK
1	305604004	PRESSER BAR BASE PLATE (UNIT)	
2	735221008	PRESSER BAR BASE PLATE	
3	735222009	NEEDLE DROP ADJUSTING PLATE	
4	000101404	SETSCREW 4X6	
5	735025000	NEEDLE BAR SUPPORTER STOPPER	
6	000138307	BOLT 4X8	
7	735026001	PRESSER BAR	
8	735027002	PRESSER BAR SPRING	
9	735028003	PRESSER BAR BRACKET	
10	000111500	HEXAGONAL SOCKET SCREW 4X8	
11	735029004	PRESSER FOOT LIFTER	
12	000001609	SNAP RING E-5	
13	735030008	TENSION RELEASE LEVER	
14	000013903	SNAP RING CS-5	
15	000081005	SETSCREW 4X8	
16	000070506	WASHER	
17	301612003	PRESSER FOOT (UNIT)	
18	660106001	SETSCREW	
19	304610000	TENSION RELEASE ARM (UNIT)	
20	739017001	TENSION RELEASE ARM BASE	
21	304045008	TENSION RELEASE ARM	
22	739019003	TENSION RELEASE SPRING	
23	000002105	SNAP RING E-3	
24	306501003	TENSION ASSEMBLY	
25	000103808	SETSCREW 3X5	
26	739016000	TOP COVER THREAD GUIDE	
27	000114802	SETSCREW 4X12	

PARTS LIST

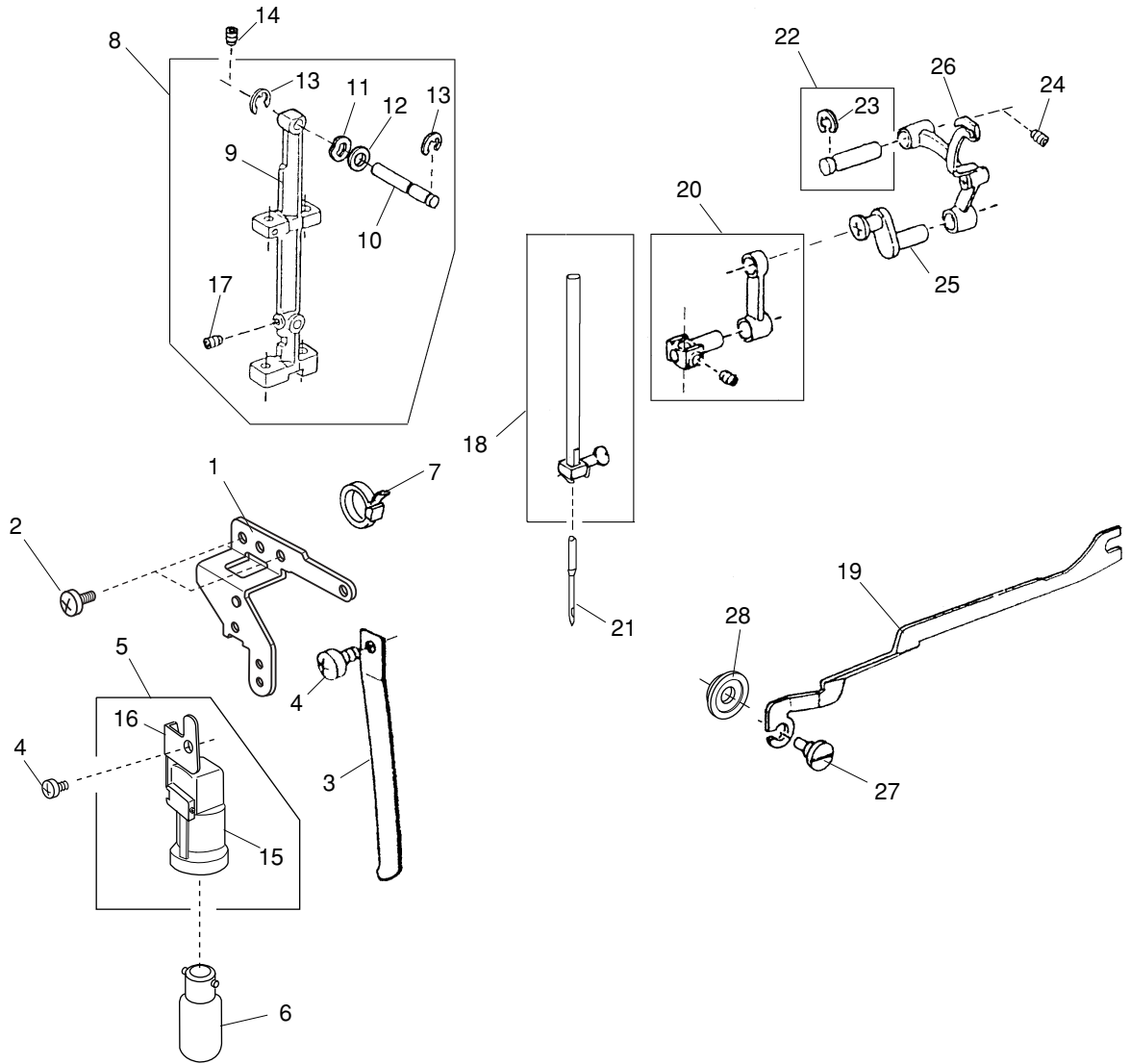

PARTS LIST

KEY NO.	PARTS NO.	DESCRIPTION	REMARK
1	740007105	FACE COVER SET PLATE (UNIT)	
2	000081005	SETSCREW 4X8	
3	730024004	NEEDLE BAR SUPPORTER SPRING	
4	000101404	SETSCREW 4X6	
5	743634003	LAMP SOCKET (UNIT)	
6	000009009	LAMP 120V 15W	
7	000053709	CORD TIE BAND	
8	301610001	NEEDLE BAR SUPPORTER (UNIT)	
9	301032003	NEEDLE BAR SUPPORTER	
10	730022002	NEEDLE BAR SUPPORTER PIN	
11	673022002	WAVE WASHER	
12	000070609	PLAIN WASHER	
13	000002507	SNAP RING E-4	
14	000111304	HEXAGONAL SOCKET SCREW 5X5	
15	655681009	LAMP SOCKET (UNIT)	
16	748026001	LAMP SOCKET SET PLATE	
17	000111902	HEXAGONAL SOCKET SCREW 3X4	
18	730503116	NEEDLE BAR (UNIT)	
19	735119002	ZIGZAG ROD	
20	680504005	NEEDLE BAR CONNECTING STUD (UNIT)	
21	102408089	NEEDLE HA1-14	
22	731511006	THREAD TAKE-UP LEVER PIN (UNIT)	
23	000002806	SNAP RING E-6	
24	000111304	HEXAGONAL SOCKET SCREW 5X5	
25	735504008	NEEDLE BAR CRANK PIN (UNIT)	
26	625506109	THREAD TAKE-UP LEVER (UNIT)	
27	678084007	ECCENTRIC PIN	
28	748021006	ZIGZAG ROD PLAIN WASHER	

PARTS LIST

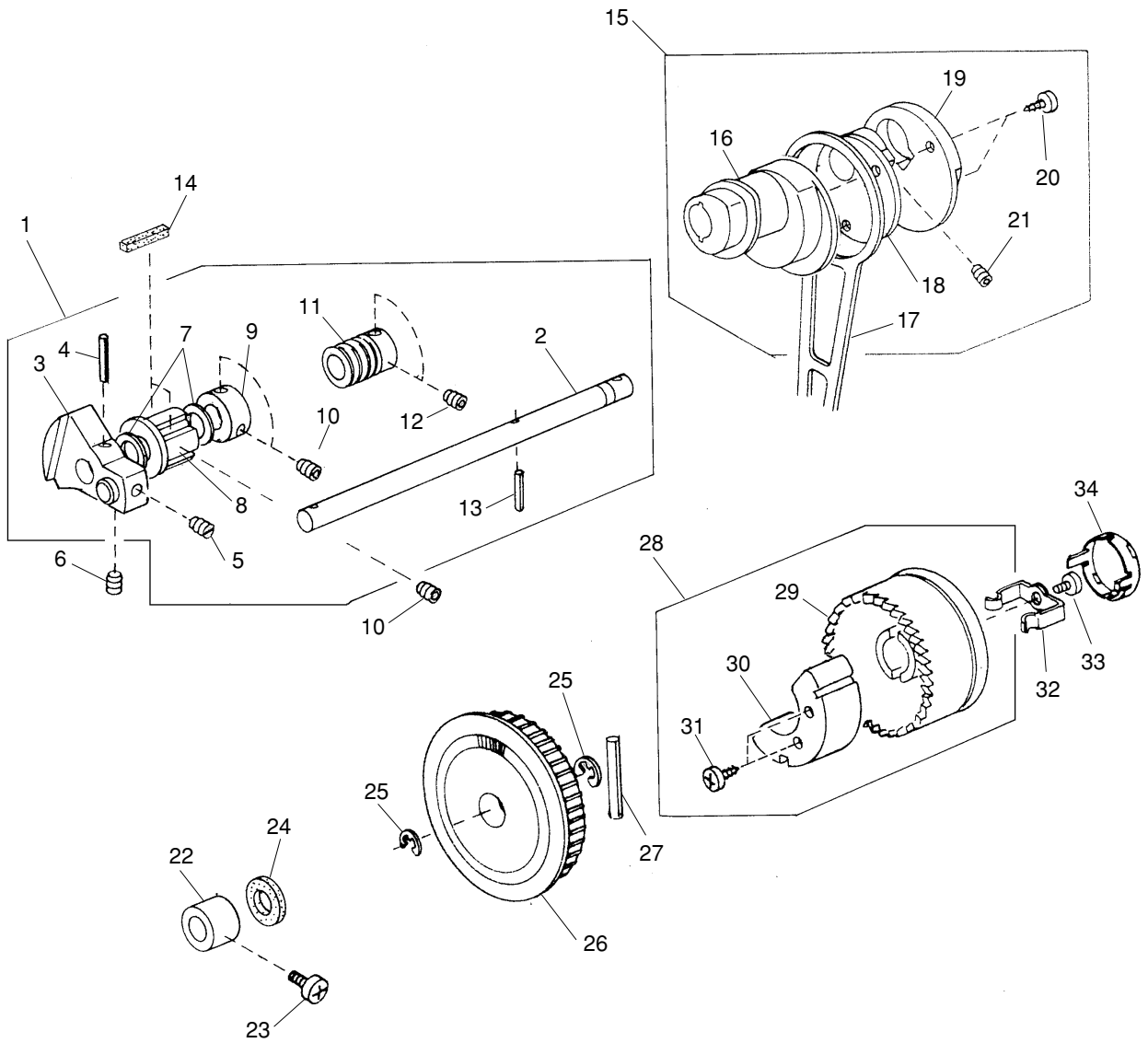

PARTS LIST

KEY NO.	PARTS NO.	DESCRIPTION	REMARK
1	304607107	UPPER SHAFT (UNIT)	
2	304041004	UPPER SHAFT	
3	743008002	TAKE-UP LEVER CRANK	
4	000021708	KNOCK PIN	
5	102073003	SETSCREW	
6	761052007	SETSCREW	
7	000036717	THRUST WASHER	
8	732025001	UPPER SHAFT FRONT BUSHING	
9	639095000	RING	
10	000111304	HEXAGONAL SOCKET SCREW 5X5	
11	751146008	WORM	
12	553245008	HEXAGONAL SOCKET SCREW 4X4	
13	000022802	SPRING PIN	
14	731312005	FELT	
15	304609006	CRANK ROD (UNIT)	
16	304042005	FEED CAM	
17	743011008	CRANK ROD	
18	304044007	CRANK CAM	
19	304043006	CRANK CAM PLATE	
20	000161309	TAPPING SCREW 3X14B	
21	000110107	HEXAGONAL SOCKET SCREW 5X5	
22	732003003	UPPER SHAFT REAR BUSHING	
23	000172602	SETSCREW 5X8	
24	743029009	FELT	
25	000030205	SNAP RING E-8	
26	743019006	BELT WHEEL	
27	000023803	SPRING PIN	
28	306605008	HANDWHEEL (UNIT)	
29	306105003	HANDWHEEL	
30	743030003	BALANCE WEIGHT	
31	000121400	TAPPING SCREW 3X14B	
32	639113016	CLUTCH SPRING	
33	000081005	SETSCREW 4X8	
34	650070060	CLUTCH CAP	

PARTS LIST

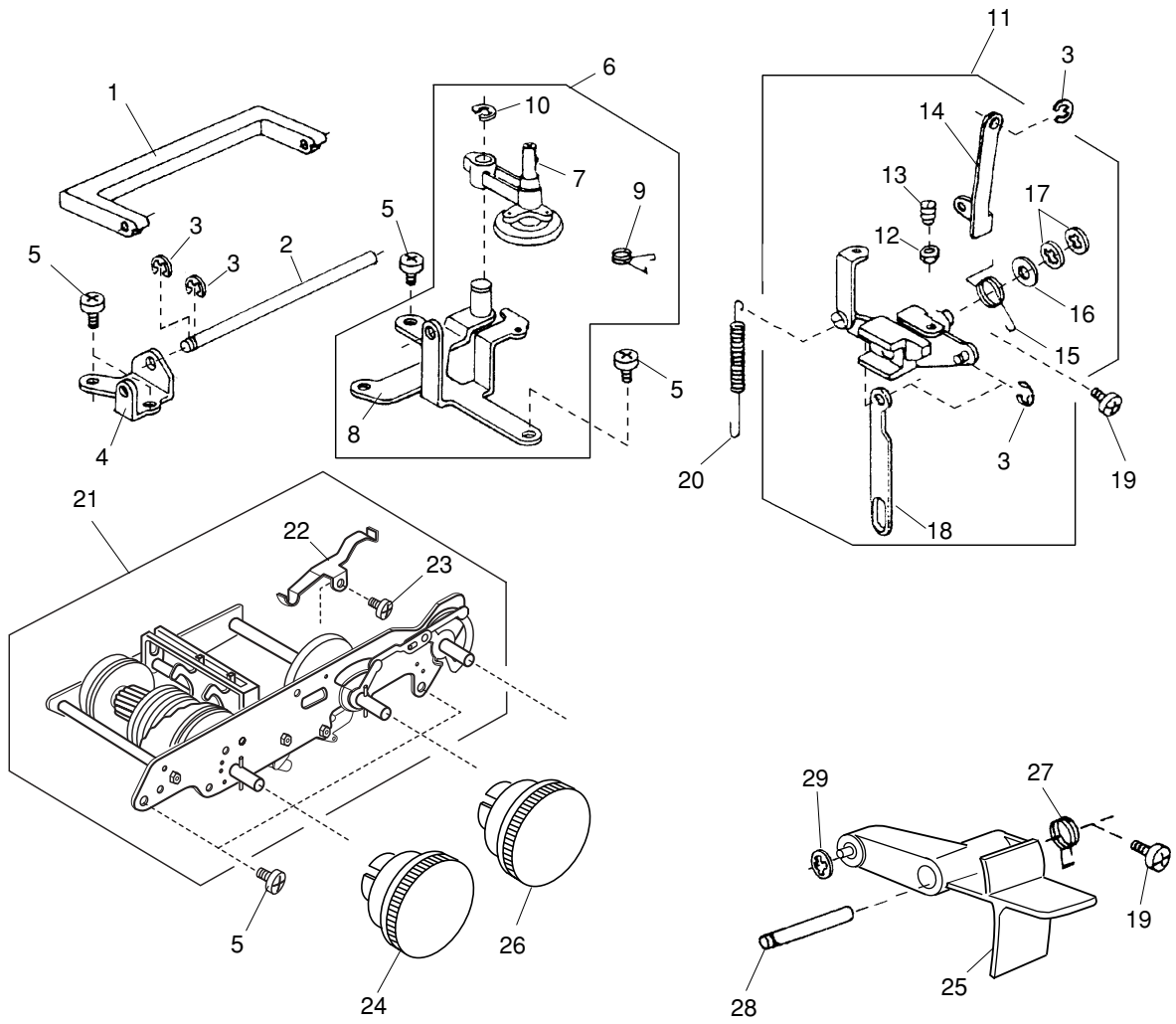

PARTS LIST

KEY NO.	PARTS NO.	DESCRIPTION	REMARK
1	735017308	HANDLE	
2	740011009	HANDLE SHAFT	
3	000002105	SNAP TING E-3	
4	740010008	HANDLE SUPPORTER	
5	000081005	SET SCREW 4X8	
6	740602209	BOBBIN WINDER BASE PLATE (UNIT)	
7	735501005	BOBBIN WINDER ARM (UNIT)	
8	740003101	BOBBIN WINDER BASE PLATE	
9	740042009	BOBBIN WINDER ARM SPRING	
10	000002806	SNAP RING E-6	
11	304611001	FEED REGULATOR (UNIT)	
12	000160102	ADJUSTABLE LOCK NUT 4	
13	648010009	SETSCREW	
14	739020007	FEED REGULATING ROD	
15	735077007	FEED REGULATING BODY SPRING	
16	735073003	PLAIN WASHER	
17	000013800	SNAP RING CS-6	
18	745052007	REVERSE LINK	
19	000101301	SETSCREW 5X10	
20	670100006	FEED REGULATOR SPRING	
21	305612108	ZIGZAG MECHANISM (UNIT)(1004)	
22	737011009	INDEX SPRING	
23	000103808	SETSCREW 3X5	
24	306108501	SELECTOR DIAL (PATTERN)(1004)	
25	306106015	R BUTTON	
26	306107201	SELECTOR DIAL (STITCH LENGTH)(1004)	
27	739063002	R BUTTON SPRING	
28	736015000	R BUTTON SHAFT	
29	000014007	SNAP RING CS-4	

PARTS LIST

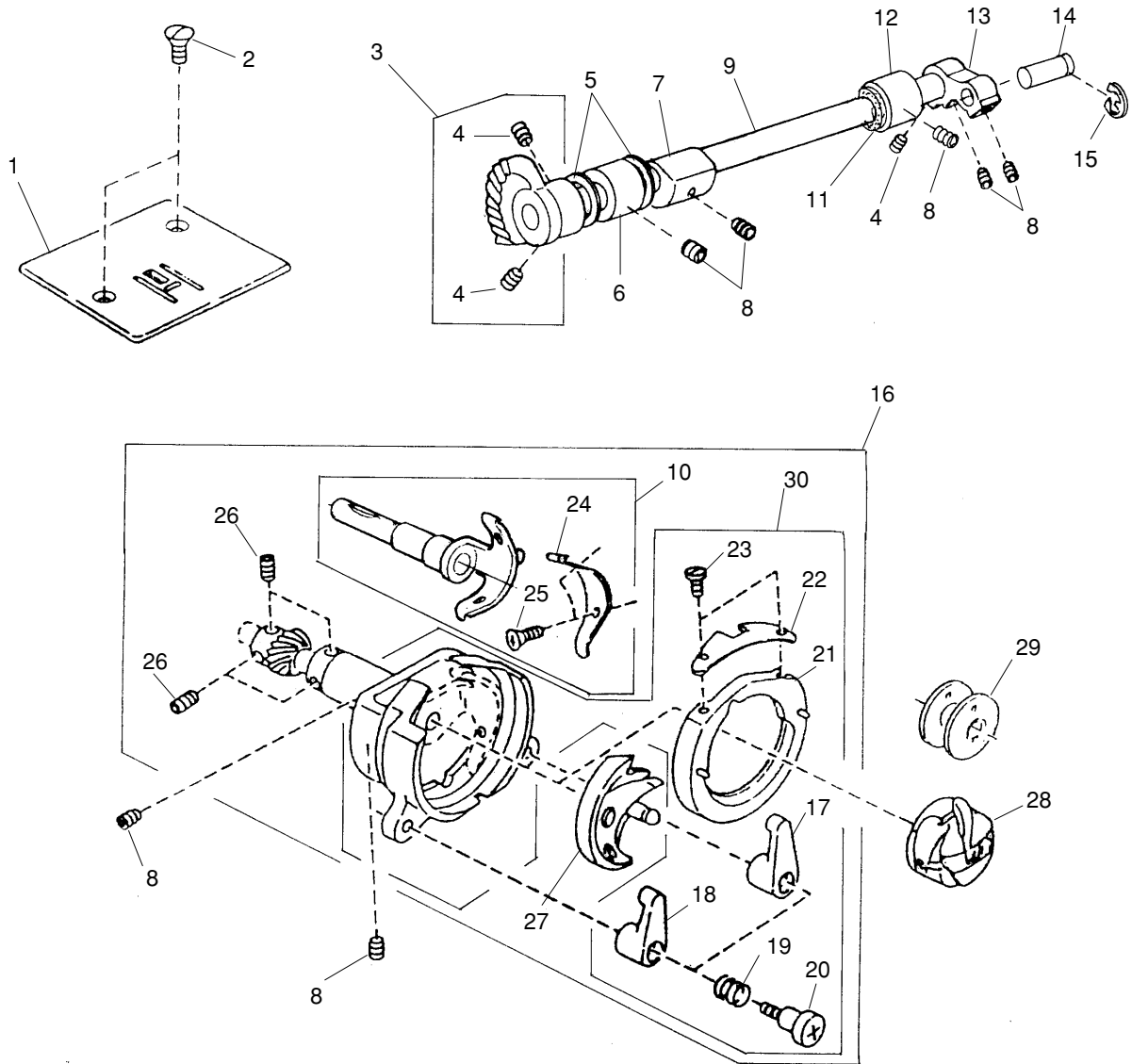

PARTS LIST

KEY NO.	PARTS NO.	DESCRIPTION	REMARK
1	744004001	NEEDLE PLATE	
2	681009101	SETSCREW	
3	735951004	LOWER SHAFT GEAR (UNIT)	
4	000110107	HEXAGONAL SOCKET SCREW 5X5WP	
5	000036201	WASHER 8-0.5	
6	735233003	BUSHING	
7	735061008	FEED LIFTING CAM	
8	000111304	HEXAGONAL SOCKET SCREW 5X5	
9	735236006	LOWER SHAFT	
10	735509003	DRIVER BODY (UNIT)	
11	822070003	FELT	
12	735234004	BUSHING	
13	639036003	LOWER SHAFT CRANK ARM	
14	639037004	PIN	
15	000001609	SNAP RING E-5	
16	735610101	SHUTTLE RACE BODY (UNIT)	
17	605065006	SHUTTLE RACE RING CLASP (RIGHT)	
18	605066007	SHUTTLE RACE RING CLASP (LEFT)	
19	639108007	SHUTTLE RACE RING CLASP SPRING	
20	673290003	HINGE SCREW	
21	553168006	SHUTTLE RACE RING	
22	601801000	SHUTTLE RACE SPRING	
23	102100000	SETSCREW	
24	670286007	SHUTTLE DRIVER SPRING	
25	102202003	PLAIN SCREW	
26	553245008	HEXAGONAL SOCKET SCREW	
27	532096007	SHUTTLE HOOK	
28	647515006	BOBBIN CASE (UNIT)	
29	102261000	BOBBIN	
30	735508105	SHUTTLE RACE BODY (UNIT)	

PARTS LIST

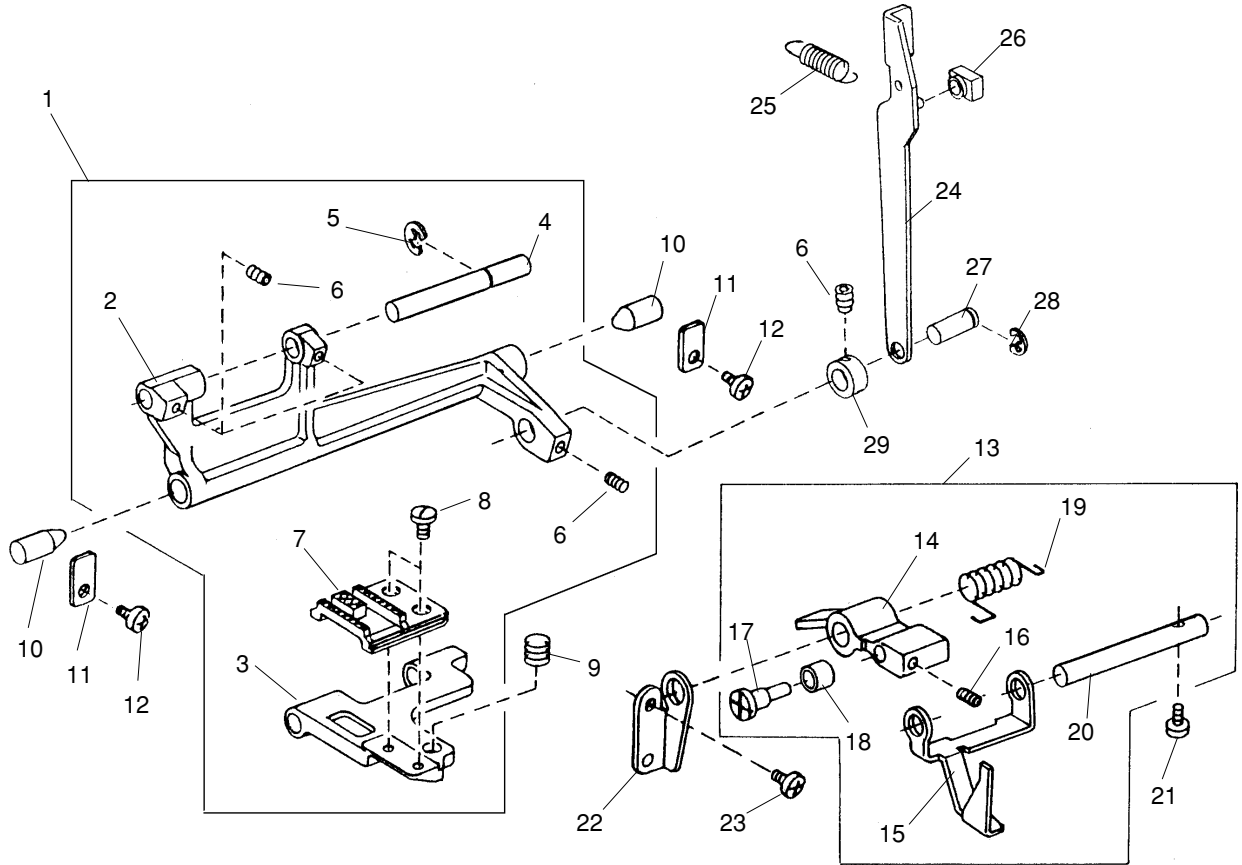

PARTS LIST

KEY NO.	PARTS NO.	DESCRIPTION	REMARK
1	735612000	FEED ROCK SHAFT (UNIT)	
2	735078008	FEED ROCK SHAFT	
3	735079009	FEED BAR	
4	735080003	FEED BAR SHAFT	
5	000002507	SNAP RING E-4	
6	000111201	HEXAGONAL SOCKET SCREW 4X4	
7	735081004	FEED DOG	
8	735082005	SETSCREW	
9	735083006	FEED BAR SPRING	
10	735084007	FEED ROCK SHAFT CENTER	
11	735085008	FEED ROCK SHAFT CENTER PLATE	
12	000101404	SETSCREW 4X6	
13	301609007	FEED LIFTING ARM (UNIT)	
14	301027005	FEED LIFTING ARM	
15	740013001	DROP FEED SELECTING PLATE	
16	000111201	HEXAGONAL SOCKET SCREW 4X4	
17	735087000	FEED LIFTING PIN	
18	735088001	FEED LIFTING ROLLER	
19	730061003	FEED LIFTING SPRING	
20	735090006	FEED LIFTING SHAFT	
21	000101703	SETSCREW 4X12	
22	739022009	FEED LIFTING SHAFT HOLDER	
23	000081119	SETSCREW 4X6	
24	743012009	FEED ROD	
25	743013000	FEED ROD SPRING	
26	102141003	FEED REGULATOR SLIDE BLOCK	
27	735071001	FEED ROCK SHAFT CONNECTING PIN	
28	000002806	SNAP RING E-6	
29	735276008	RING	

PARTS LIST

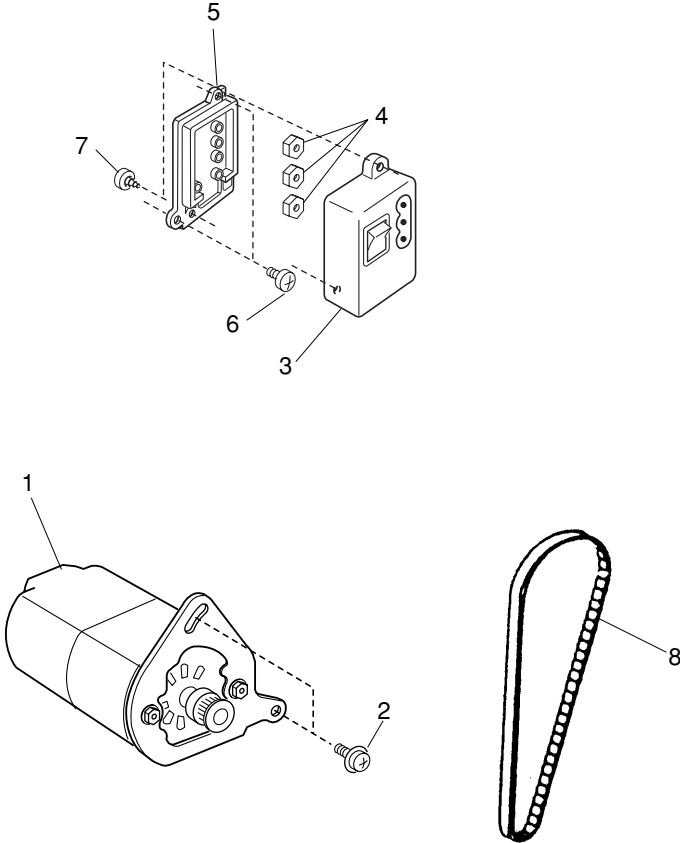

PARTS LIST

KEY NO.	PARTS NO.	DESCRIPTION	REMARK
1	743611303	MOTOR ASSY	
2	000201209	SETSCREW 5X12	
3	739503308	MACHINE SOCKET (UNIT)	
4	000060802	NUT	
5	739037007	MACHINE SOCKET COVER	
6	000103509	SETSCREW 4X10	
7	000107802	SETSCREW 3X10	
8	650166008	MOTOR TIMING BELT	

PARTS LIST

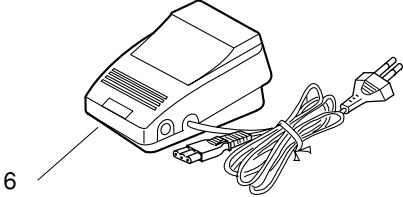
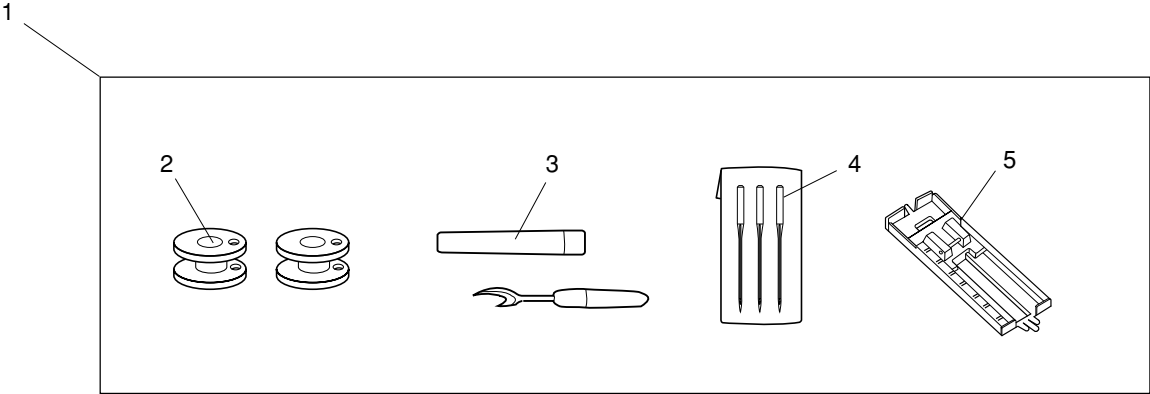

PARTS LIST

KEY NO.	PARTS NO.	DESCRIPTION	REMARK
1	747870265	ACCESSORY SET	
2	102261000	BOBBIN	
3	647808009	SEAM RIPPER	
4	639804000	NEEDLE SET	
5	639801007	BUTTONHOLE FOOT	
6	042870205	FOOT CONTROL	